

WERKZEUG, DAS SICH EINBRENNT.



# FAHRRAD 2021



Follow us!



GÜLTIG VOM 01.01.2021 – 31.12.2021

EINFACH VIGOR.

V-BIKE2021/DE/0

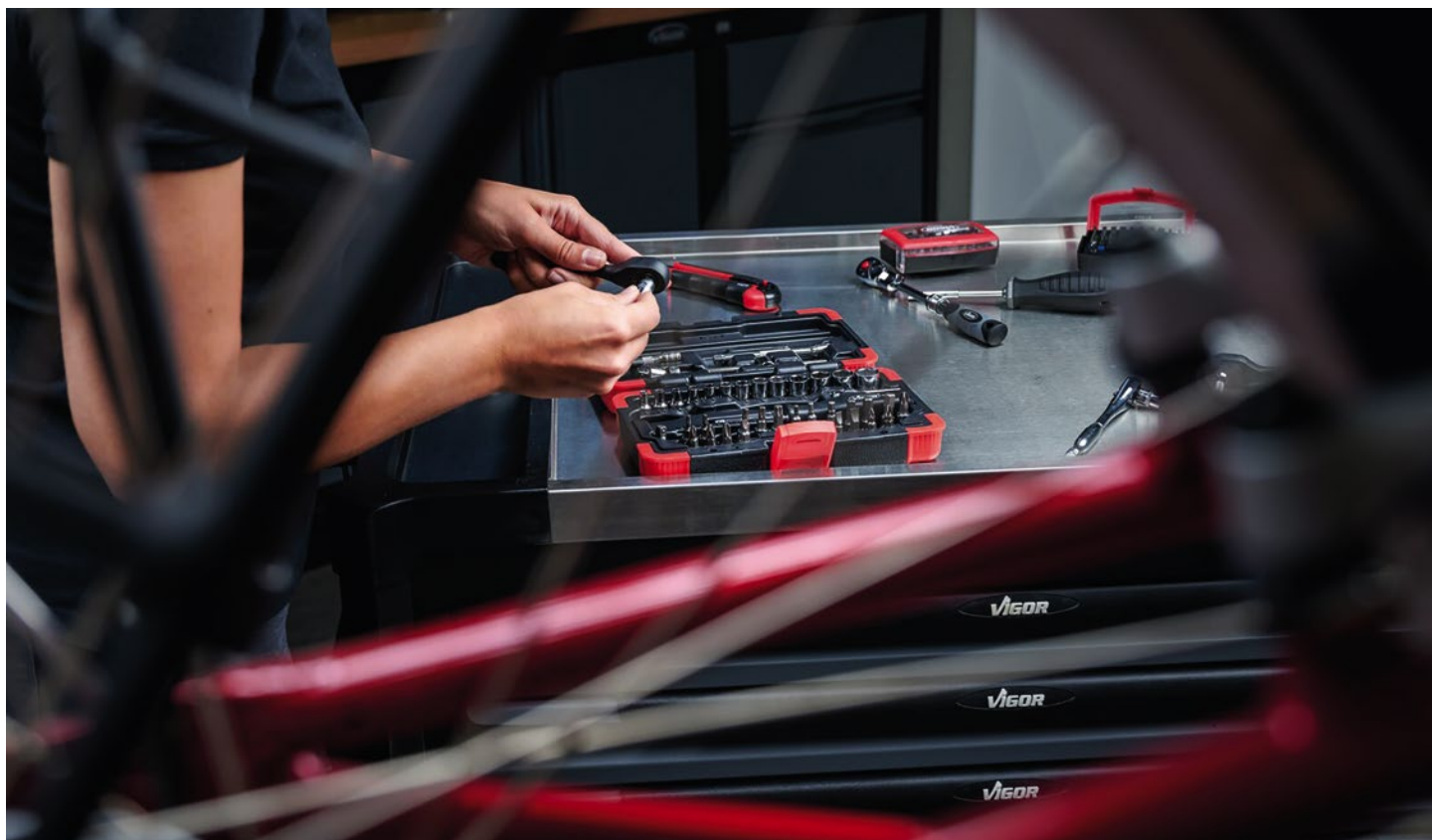

6.3 1/4"    

**V3734N**

**Steckschlüssel-Satz**

- 4 · 4.5 · 5 · 5.5 · 6 · 7 · 8 · 9 · 10 · 11 · 12 · 13 mm
- PH 1 · PH 2
- PZ 1 · PZ 2
- T 15 · T 20 · T 25 · T 30



**23**



EAN 4047728056427

6.3 1/4"      

**V2414N**

**Steckschlüssel-Satz**

- 4 · 4.5 · 5 · 5.5 · 6 · 7 · 8 · 9 · 10 · 11 · 12 · 13 mm
- PH 1 · PH 2
- PZ 1 · PZ 2
- T 15 · T 20 · T 25 · T 30



**46**



EAN 4047728056434



**V6019**  
**Innensechskant  
 Schraubendreher-Einsatz Sortiment**  
 EAN 4047728065900  
 • Abtrieb: Innensechskant Profil



**V6017**  
**TORX®  
 Schraubendreher-Einsatz Sortiment**  
 EAN 4047728064361  
 • Abtrieb: Innen TORX® Profil



**V5202**  
**Steckschlüssel-  
 Satz, superflach**  
 EAN 4047728068987  
 • Inkl. Bit-Halter und Bits!



**V6202**  
**Steckschlüssel-  
 Satz, superflach**  
 EAN 4047728062022

**Superflach,  
 superkurz,  
 superpraktisch!**

Durchgängiger  
 Steckschlüssel-  
 Einsatz ermöglicht Lösen von  
 Verschraubungen an Stehbolzen!

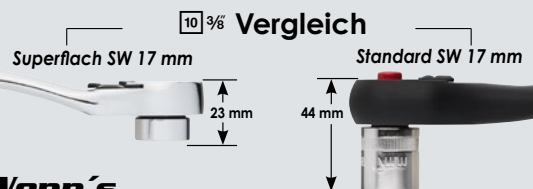

**Wenn's  
 mal eng wird!**



6.3 1/4" 10 3/8" 12.5 1/2"

## Feinzahn-Umschaltknarren

- Gekröpfte Ausführung
- Kunststoffummantelt
- Mit Auslöseknopf
- DIN 3122, ISO 3315



12.5 1/2"



10 3/8"



6.3 1/4"

### V6012

EAN 4047728055826

250 mm



### V6038

EAN 4047728055840

198 mm



### V6014

EAN 4047728055833

150 mm

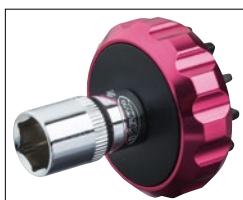

6.3 1/4" 6.3 1/4"

### V2941

## Fingerratsche

- 72 Zähne
- 5° Betätigungswinkel



EAN 4047728029414

6.3 1/4 10 3/8 12.5 1/2

# Feinzahn-Umschaltknarren

- Leicht zu reinigen
- Geschlossenes System
- Robust und servicefreundlich



**Standard und lange Ausführungen!**

|   | VIGOR No. | Bezeichnung                      | l<br>mm | EAN<br>4047728+ |
|---|-----------|----------------------------------|---------|-----------------|
| ① | V4944-S   | 6.3 1/4 Feinzahn-Umschaltknarre  | 150     | 055345          |
| ② | V4944     | 6.3 1/4 Feinzahn-Umschaltknarre  | 200     | 049443          |
| ③ | V4945-S   | 10 3/8 Feinzahn-Umschaltknarre   | 198     | 055352          |
| ④ | V4945     | 10 3/8 Feinzahn-Umschaltknarre   | 275     | 049450          |
| ⑤ | V4946-S   | 12.5 1/2 Feinzahn-Umschaltknarre | 250     | 055369          |
| ⑥ | V4946     | 12.5 1/2 Feinzahn-Umschaltknarre | 380     | 049467          |



Unsere Reparatursätze findest Du im VIGOR Katalog!

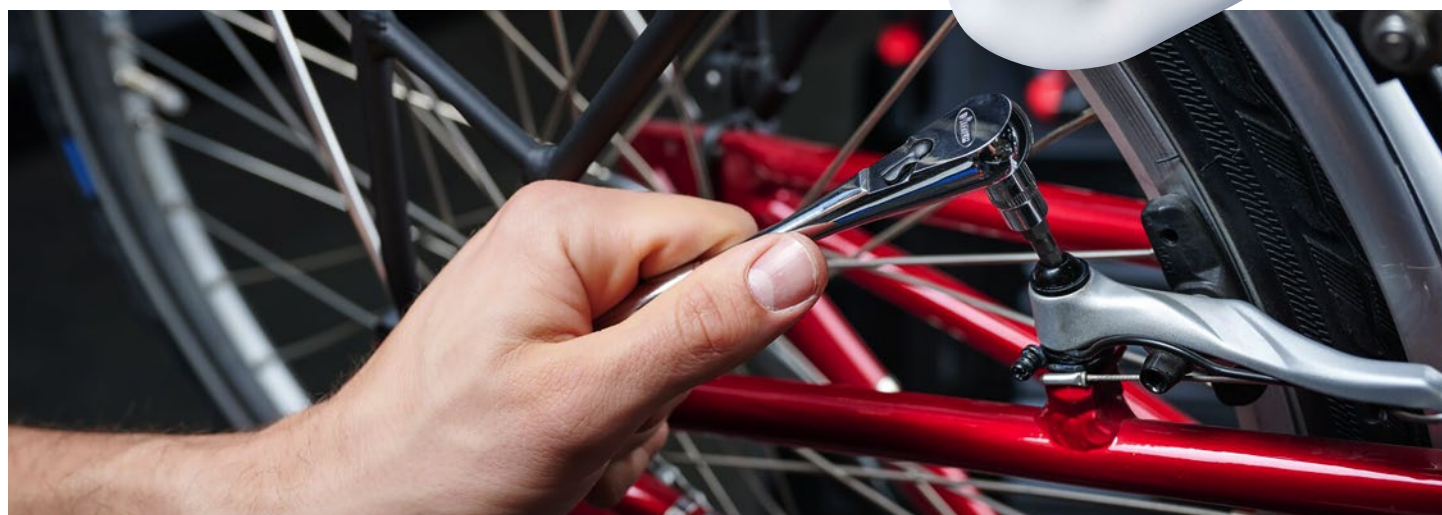

**V5502**
**30**
**Bit Box**

- Schraubarbeiten in Werkstatt, Industrie, Handwerk, Heim und Hobby
- ~ DIN / ISO

EAN 4047728055024

**Inhalt:**

| X   |         |         | Ausführung | SW mm   |
|-----|---------|---------|------------|---|
| 4 x | 6.3 1/4 | +       |            | PH 1 · PH 2 (2x) · PH 3                                       |
| 4 x | 6.3 1/4 | +       |            | PZ 1 · PZ 2 (2x) · PZ 3                                       |
| 4 x | 6.3 1/4 | ●       |            | 4 x 0,8 · 5 x 1 · 6,5 x 1,2<br>8 x 1,6 mm                     |
| 4 x | 6.3 1/4 | ○       |            | 3 · 4 · 5 · 6 mm  |
| 7 x | 6.3 1/4 | +       |            | T 10 · T 15 · T 20 · T 25 ·<br>T 27 · T 30 · T 40             |
| 7 x | 6.3 1/4 | +       |            | T 10 H · T 15 H · T 20 H · T 25 H<br>T 27 H · T 30 H · T 40 H |
| 1 x | 6.3 1/4 | 6.3 1/4 |            | -   |
| 1 x | 6.3 1/4 | 6.3 1/4 | -          | -   |

**TORX® Schraubendreher-Einsätze**

**6.3 1/4**

| VIGOR No. | SW mm | ← L → mm | EAN 4047728+ |
|-----------|-------|----------|--------------|
| V2443N    | T15   | 38       | 058025       |
| V2444N    | T20   | 38       | 058032       |
| V2445N    | T25   | 38       | 058049       |
| V2446N    | T30   | 38       | 058056       |

**TORX® Schraubendreher-Einsätze**

**10 3/8**

| VIGOR No. | SW mm | ← L → mm | EAN 4047728+ |
|-----------|-------|----------|--------------|
| V2303N    | T15   | 49       | 057493       |
| V2302N    | T20   | 49       | 057486       |
| V2301N    | T25   | 49       | 057479       |
| V2299N    | T30   | 49       | 057455       |



**V2820**

**Ratschen-Ring-Maulschlüssel Satz, lang**

- 72 Zähne
- 5° Betätigungswinkel
- SW 8 · 10 · 13 · 17 · 19 mm



EAN 4047728028202



**V4951**

**Maul-Ratschenschlüssel Satz**

- Integrierte Ratschenfunktion an der Maulseite des Schlüssels:
- Arbeiten auch bei schwierigen Platzverhältnissen
  - Vereinfachte Mechanik zur Minimierung von Schwachstellen
  - Inklusive Rolltasche



EAN 4047728049511



**V4473N**

**Ring-Maulschlüssel**

- Lange Ausführung
- 15° gekröpfter Ringschlüssel
- Abtrieb: Außen-Sechskant Profil, Außen-Doppel-Sechskant Profil
- Oberfläche: mattverchromt



**V3607**

**Doppel-Ratschen-Ringschlüssel**

EAN 4047728036078

| VIGOR No. | SW mm | l mm | EAN 4047728+ |
|-----------|-------|------|--------------|
| V4473N-8  | 8     | 115  | 064453       |
| V4473N-10 | 10    | 135  | 064477       |
| V4473N-13 | 13    | 185  | 064507       |
| V4473N-15 | 15    | 185  | 064323       |

| VIGOR No. | SW mm        | a1 mm | a2 mm | l mm | EAN 4047728+ |
|-----------|--------------|-------|-------|------|--------------|
| V3607     | 8x12 · 10x13 | 12,5  | 14,5  | 220  | 036078       |

Schlanker, stabiler Griff

Aufhängeloch

Spannbereich 0-24 mm

mm-Skala am Schlüsselkopf

**V6048**

**Rollgabelschlüssel**

EAN 4047728069625

- Einhandverstellung der Schlüsselweite durch Verstellrad am Schlüsselkopf
- Maulstellung 15° abgewinkelt
- Gut lesbare mm-Skala am Schlüsselkopf
- Spannbereich 0-24 mm

**V1409**

**Sechskant T-Griff Schraubendreher Satz**

• SW: 2 · 2.5 · 3 · 4 · 5 · 6 · 8 · 10 mm

**V1410**

**TORX® T-Griff Schraubendreher Satz**

• SW: T9 · T10 · T15 · T20 · T25 · T27 · T30 · T40

**V4942**

**Winkel-schraubendreher Satz**

• Im Clip

• Lange Ausführung

• Kugelkopf

• Inhalt: 1,5 · 2 · 2,5 · 3 · 4 · 5 · 6 · 8 · 10 mm

**V4708**

**TORX® Winkel-schraubendreher Satz**

• Im Clip

• Lange Ausführung

• Kugelkopf

• Inhalt: T10 · T15 · T20 · T25 · T27 · T30 · T40 · T45 · T50





**V1637**

**Schraubendreher Satz**

- Nach DIN/ISO gefertigt
- $\ominus$  0.6x3 · 0.8x4 · 1.0x5.5 · 1.2x6.5 mm
- $\oplus$  PH0 · PH1 · PH2



EAN 4047728016377



**V3366**

**TORX® Schraubendreher Satz**

- Nach DIN/ISO gefertigt
- $\odot$  T10 · T15 · T20 · T25 · T27 · T30 · T40



EAN 4047728033664



**V1616**

**Kombizange**



EAN 4047728016162



**V2412**

**Flachrund-Zange**



EAN 4047728024129

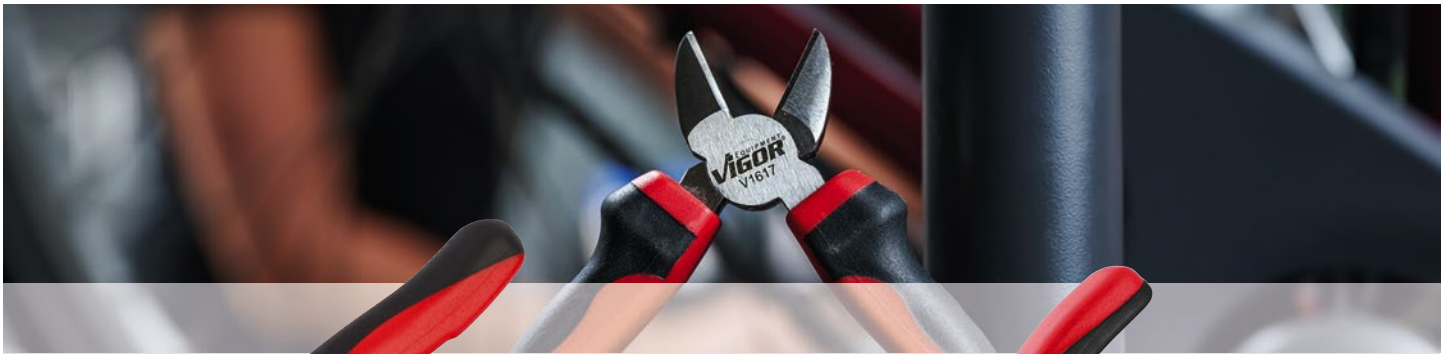

2K System

**V1617**

**Seitenschneider**

EAN 4047728016179



2K System

ESD Version

**V5681**

**Elektronik-Seitenschneider**

EAN 4047728056816

- Für Drahtklassen:
  - Weich bis  $\varnothing$  1,6 mm
  - Mittelhart bis  $\varnothing$  1,2 mm
  - Hart bis  $\varnothing$  0,8 mm



Mit Zwangssperre

2K System

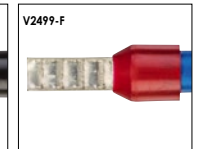
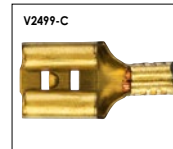

**V2499**

**Crimpzangen Satz**



EAN 4047728024990

Fünf auswechselbare Crimp-Einsätze:

- Crimp-Einsatz A: für isolierte Kabelschuhe 0,5–6,0 mm<sup>2</sup> (rot, blau, gelb)
- Crimp-Einsatz B: für geschlossene, unisolierte Kabelschuhe 1,5 · 2,5 · 6,0 · 10 mm<sup>2</sup>
- Crimp-Einsatz C: für offene, unisolierte Kabelschuhe 0,5–6,0 mm<sup>2</sup> (Breite bis 6,3 mm)
- Crimp-Einsatz D: für Ader-Endhülsen mit und ohne Kragen 0,5–4,0 mm<sup>2</sup>
- Crimp-Einsatz F: für Ader-Endhülsen über 6,0 mm<sup>2</sup>

| VIGOR No.      | Bezeichnung  | EAN 4047728+  |
|----------------|--|---------------|
| <b>V2499-A</b> | Crimp-Einsatz A: für isolierte Kabelschuhe von 0,5 – 6,0 mm <sup>2</sup> (rot, blau, gelb)             | <b>053440</b> |
| <b>V2499-B</b> | Crimp-Einsatz B: für geschlossene, unisolierte Kabelschuhe von 1,5 · 2,5 · 6,0 · 10 mm <sup>2</sup>    | <b>053457</b> |
| <b>V2499-C</b> | Crimp-Einsatz C: für offene, unisolierte Kabelschuhe von 0,5 – 6,0 mm <sup>2</sup> (Breite bis 6,3 mm) | <b>053464</b> |
| <b>V2499-D</b> | Crimp-Einsatz D: für Aderendhülsen mit und ohne Kragen von 0,5 – 4,0 mm <sup>2</sup>                   | <b>053471</b> |
| <b>V2499-F</b> | Crimp-Einsatz F: für Aderendhülsen über 6,0 mm <sup>2</sup>  | <b>053488</b> |



**V4427**

**Sicherungsring-  
Zange**

- Gerade Ausführung (Form C)
- Für Innensicherungen X 12-25 mm
- Spitzen-Durchmesser: 1,3 mm



EAN 4047728044271

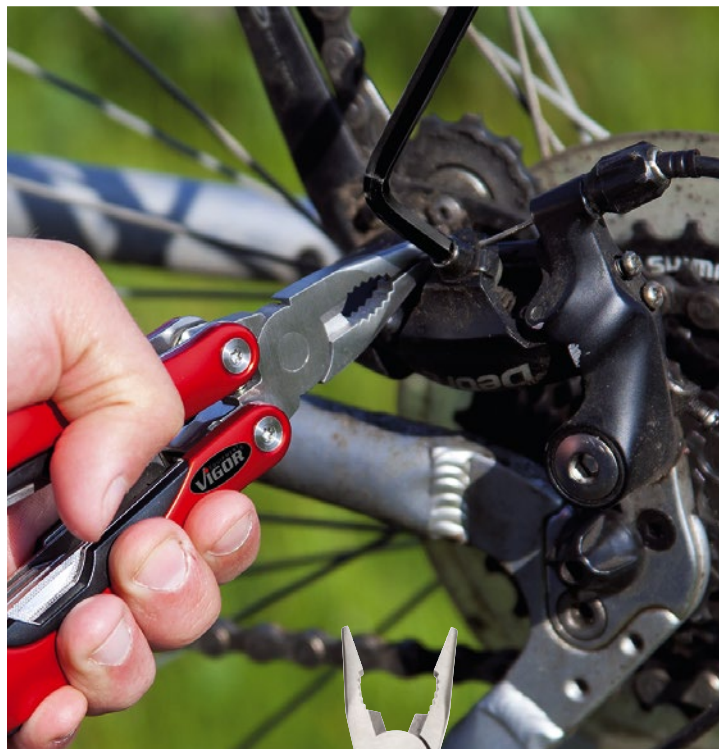

**V1785**

**Multi-Tool  
14-in-1**



EAN 4047728017855



**V4429**

**Sicherungsring-  
Zange**

- Gerade Ausführung (Form A)
- Für Außensicherungen X 10-25 mm
- Spitzen-Durchmesser: 1,3 mm

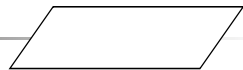

EAN 4047728044295



**V1426N**

**Universalzange**



EAN 4047728064392



**Denk` dran, direkt mitbestellen!**



**V1212**

**Kunststoff-Schonhammer**

- Auswechselbare Köpfe aus schlagfestem Cellulose-Acetat
- Eschestiel
- Länge: 280 mm
- Ø 32 mm



EAN 4047728012126

**V3541**

**Ersatzkopf (Paar)**

- Ersatzkopf (Paar) für Kunststoff-Schonhammer V1212

EAN 4047728035415



**V1135**

**Schlosserhammer**

- Eschestiel
- Länge: 300 mm
- $\frac{3}{8}$  300 g

EAN 4047728011358



**V1715**

**Sägebogen**

- Für handelsübliche Sägeblätter
- Inklusive 1 Sägeblatt

EAN 4047728017152



Ø 3 - 16 mm

**V2626**

**Rohrschneider**

- Für Rohre aus Kupfer, Messing, Leichtmetall und PVC-Hartkunststoff

EAN 4047728026260

***Perfekt zum Kürzen des Lenkers!***

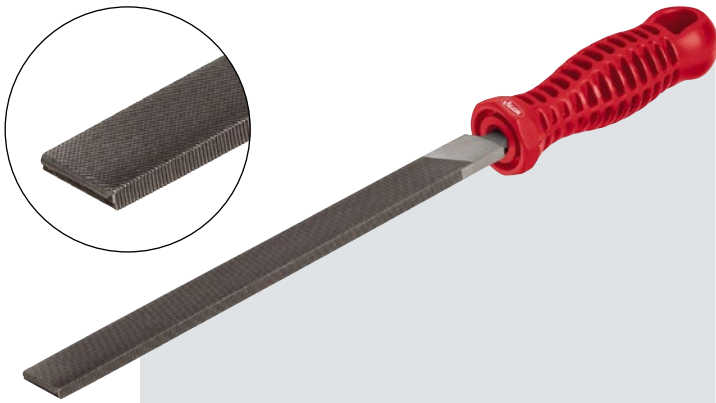

**V1787**

**Flachstumpf-Feile**

- Zahnung (Hieb): 2 = mittel
- DIN 7261



EAN 4047728017879

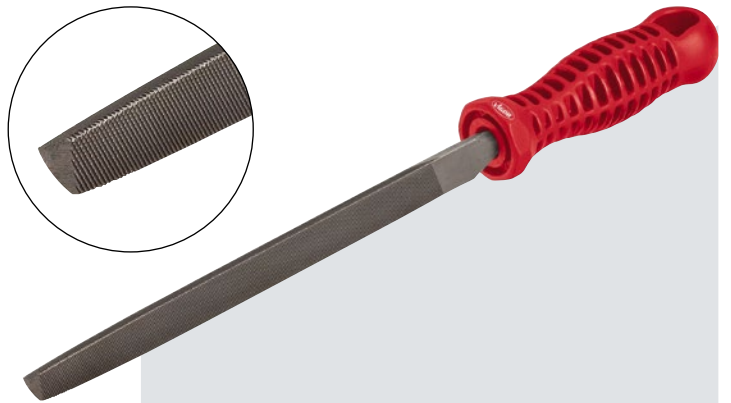

**V1788**

**Dreikant-Feile**

- Zahnung (Hieb): 2 = mittel
- DIN 7261



EAN 4047728017886

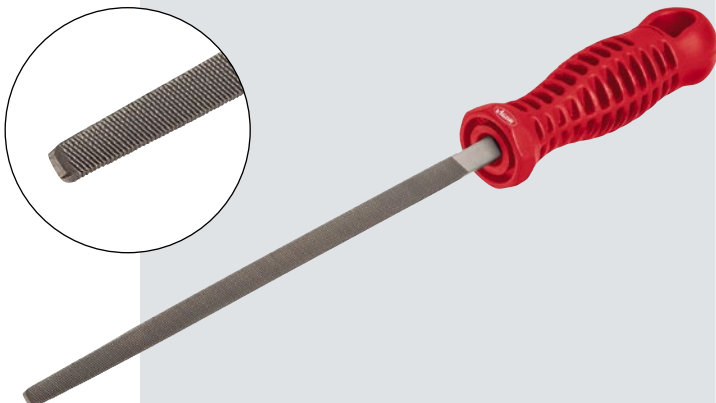

**V1789**

**Vierkant-Feile**

- Zahnung (Hieb): 2 = mittel
- DIN 7261



EAN 4047728017893

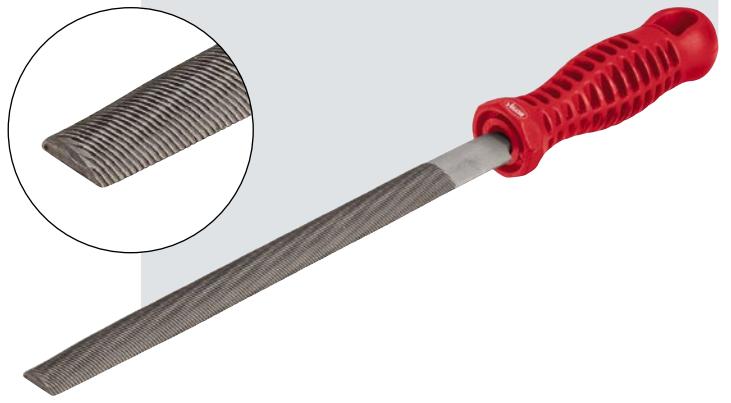

**V1790**

**Halbrund-Feile**

- Zahnung (Hieb): 2 = mittel
- DIN 7261



EAN 4047728017909

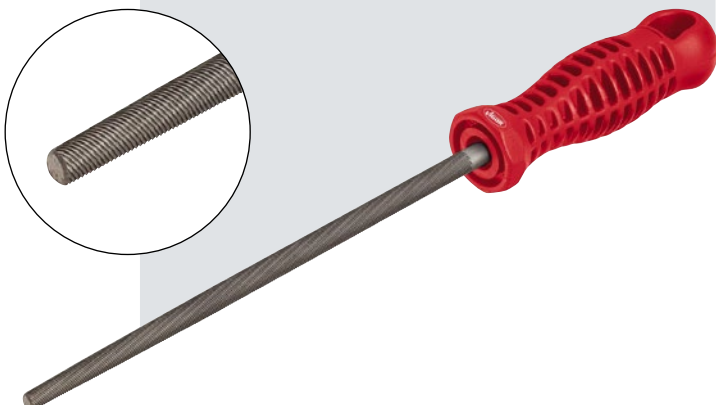

**V1801**

**Rund-Feile**

- Zahnung (Hieb): 2 = mittel
- DIN 7261

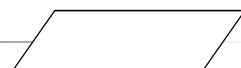

EAN 4047728018012



**V1304**

**Universalschere**

- Lange, hochwertige Schneiden
- Klinge aus Edelstahl

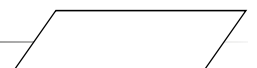

EAN 4047728013048



**V7099/2**

**Universal Klappmesser Satz**



EAN 4047728071123

**Denk` dran, direkt mitbestellen!**

**V1446**

**Trapez-Ersatzklingen für V7099**



**10**

EAN 4047728014465

**V1447**

**Trapez-Ersatzklingen für V7099-S**



**10**

EAN 4047728070966



**Slipper-Schlüssel**



Hauptskala

Feinskala  
Skalenteilung 0,1 Nm

**6.3 1/4"**

**2-10 Nm**

**V4431-1**

**T-Griff Drehmoment-Schraubendreher**

EAN 4047728044325

- Drehmoment-Auslösung: Haptisch und akustisch
- Slipper-Schlüssel mit Überlastkupplung → kein Überziehen
- Nur Rechtsanzug → kein Lösen von Verschraubungen
- Für Verschraubungen bei Reifendruck-Kontroll-Systemen (RDKS)
- DIN EN ISO 6789-2:2017, Vierkant nach DIN 3120, ISO 1174-1A



### V7135

#### Ausblas-Pistole, kurz

EAN 4047728071352

- Luftanschluss Einlass: Innengewinde 12,91 mm (1/4")
- Betriebsdruck (bar): 6 bar
- Schlauchdurchmesser (empfohlen): 10 mm
- Schall-Druckpegel (bei Betriebsdruck): 102 dB(A) Lp A

### V7143-10

#### Schlauchaufroller, 15 m

EAN 4047728071437

- Reduzierte Unfallgefahr, da kein Schlauch herumliegt
- Kompaktes Gehäuse, inklusive Öffnungsklappe zur Beseitigung von Schmutz oder zum Richten des Schlauches
- Wandhalterung: 180° Schwenkbereich
- Automatisches Aufrollen durch geführten Einzug
- Druckluft Adapter vorinstalliert
- Hybrid Polymer-Schlauch
- Auto Stop Funktion
- Schlagfestes Polypropylen Gehäuse
- Angepasste Einzugskraft
- Maximaler Betriebsdruck 12 bar
- Inklusive Kupplungsstecker und Kupplungsbuchse



### V6905

#### Reifenfüller

EAN 4047728069052

- Einhandbedienung mit ergonomischem Griff
- Gummiummanteltes Manometer zum Schutz vor leichten Stößen
- Leicht ablesbares Präzisionsmanometer mit bar und PSI-Angabe
- Teilung: 0,1 bar
- Gut dosierbarer Füllhebel und Ablassknopf, einfach am Handgriff erreichbar
- Ablassknopf zur Nivellierung der Befüllmenge





# Entscheide selbst - MIT oder OHNE Sortiment!

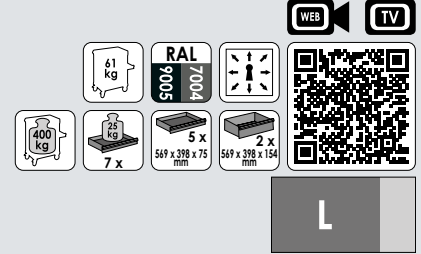
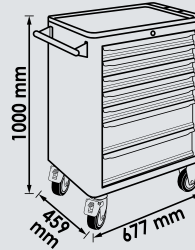

**V5489**

Werkstattwagen, leer

EAN 4047728054898

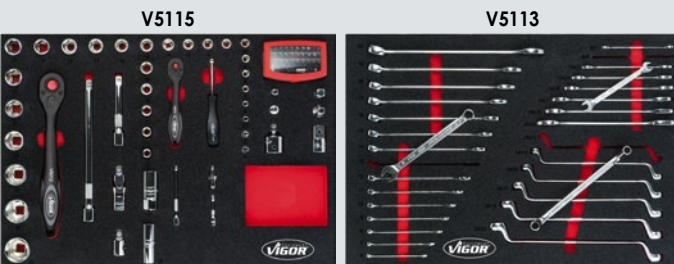

**V2379N**

Werkstattwagen mit 164 Profiwerkzeugen

EAN 4047728055444

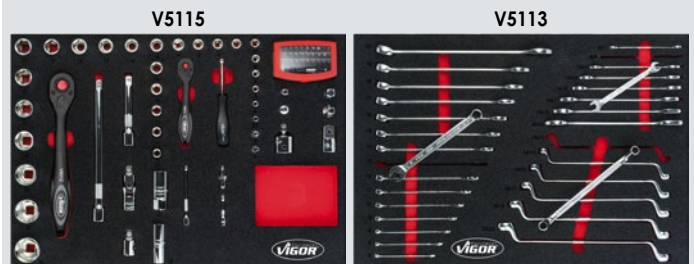

**V2712N**

Werkstattwagen mit 228 Profiwerkzeugen

EAN 4047728055451

V6000-3P1

## DAS STARTER-PAKET

XL

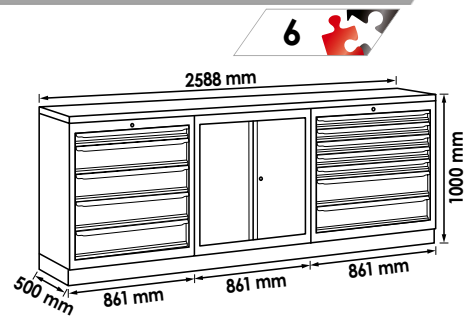

- 3-Modul Kombination in breiter Ausführung
- Mit Holz- oder Edelstahl-Arbeitsplatte erhältlich
- Inklusive Seitenverblendung



| VIGOR No.     | Bezeichnung                                     | EAN<br>4047728+ |
|---------------|---|-----------------|
| V6000-3P1XL   | Schrankwand-Kombination Starter-Paket Holz      | 073318          |
| V6000-3P1XL-X | Schrankwand-Kombination Starter-Paket Edelstahl | 073271          |

**NEU**

V6000-3P2

## DAS KOMPLETT-PAKET

XL

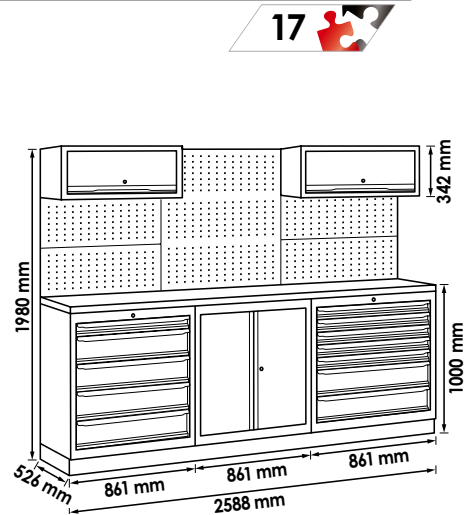

- 3-Modul Kombination in breiter Ausführung mit Lochwandaufbau und Hängeschränken
- Mit Holz- oder Edelstahl-Arbeitsplatte erhältlich
- Inklusive Seitenverblendung



| VIGOR No.     | Bezeichnung                                      | EAN<br>4047728+ |
|---------------|--|-----------------|
| V6000-3P2XL   | Schrankwand-Kombination Komplett-Paket Holz      | 073301          |
| V6000-3P2XL-X | Schrankwand-Kombination Komplett-Paket Edelstahl | 073295          |

**NEU**



Alle Pakete mit Edelstahl- oder Holz-Arbeitsplatte erhältlich!

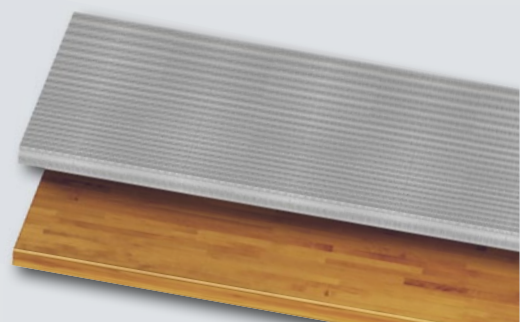

V6000-3

# DAS KOMPAKT-PAKET

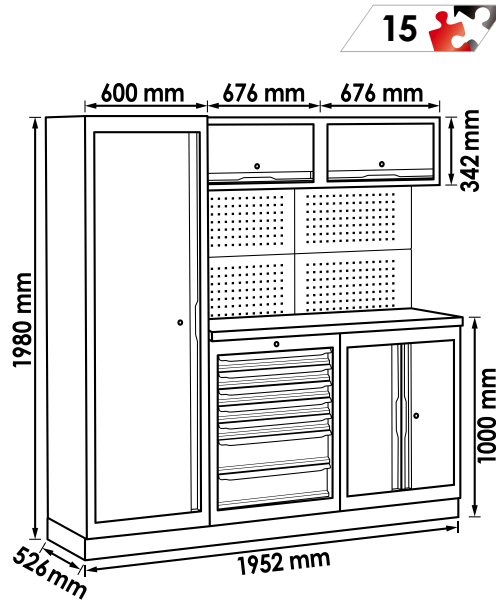

15

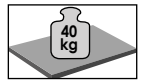

- 3-Modul Kombination in schmaler Ausführung mit Hochschrank, Lochwandaufbau und Hängeschränken
- Mit Holz- oder Edelstahlworktop erhältlich
- Inklusive Seitenverblende

| VIGOR No. | Bezeichnung                                     | EAN<br>4047728+ |
|-----------|---|-----------------|
| V6000-3   | Schrankwand-Kombination Kompakt-Paket Holz      | 048729          |
| V6000-3-X | Schrankwand-Kombination Kompakt-Paket Edelstahl | 073288          |

**NEU**





mm ←  
← inch

Umschaltung mm / inch

### V1713

#### Messschieber, digital

EAN 4047728017138

- Außen- und Innen-Messung im Bereich 0–150 mm
- Millimeter- und Zoll-Teilung
- Digitale Anzeige
- 1,5 V (LR 44) – 180 mAh
- Feststellschraube
- Tiefen-Messstab
- Im Kunststoffkasten
- Länge: 235 mm



### V4690

#### Messschieber, analog

EAN 4047728046909

- Außen- und Innen-Messung im Bereich 0–150 mm
- Millimeter- und Zoll-Teilung
- Nonius 0,05 mm und  $\frac{1}{128}''$
- Feststellschraube
- Tiefen-Messstab
- Im Kunststoffkasten
- Länge: 235 mm
- DIN 862



### V5591

#### Bandmaß

EAN 4047728055918

- Millimetergenaue Ermittlung kurzer Distanzen bis 5 m
- Länge: 5 m, Breite: 19 mm
- Handschleife und Gürtelclip
- Magnetischer Anschlag
- Handregulierter Bandezug und Bandlaufperre
- Stabiler Federbandstahl



**V5677**

**Magnetschale mit Kunststoff-Rahmen**

- Kunststoff-Rahmen bietet Ablagefläche für Kunststoffschrauben o.Ä. und dient dadurch zusätzlich als Auffangschale
- Magnetschale beidseitig magnetisch – magnetische Kleinteile haften an der Rückwand
- Maße: 240 x 140 x 28 mm

EAN 4047728056779



**V5678**

**Magnet-Halbschale**

- Für die Werkstatt, Produktionsstätte oder den Hobbykeller
- Stabiles Kunststoffgehäuse mit optimiertem Magneten
- Zusätzliche Stabilisierung unterhalb des Magneten für planes Aufliegen der Halbschale
- Magnethaltkraft: ca. 2,5 kg

EAN 4047728070539



**V6435**

**Arbeitshandschuhe**

- Hohe Griff- und Rutschfestigkeit
- Montagearbeiten in der Werkstatt, Lager / Logistik und überall dort, wo hohe Griffsicherheit und Präzision wichtig sind
- Leichte Polyester-Strickhandschuhe mit ergonomischer Passform
- EN 388:2003 (3131A)

| VIGOR No. | Größe | EAN 4047728+ |
|-----------|-------|--------------|
| V6435     | 9     | 064354       |
| V6435-XL  | 10    | 069984       |



*Komfortables und gelenkschonendes Arbeiten in der Werkstatt, Industrie, im Garten oder Haushalt!*

**V2338**

**Kniekissen**

- Hochwertiger Schaumstoff
- Knieschonend
- Wärmeisolierend
- Mit Tragegriff
- Maße: 475 x 235 x 26 mm

EAN 4047728023382



**V6809-4**

**Drahtbürste, Stahl, 4-reihig**

- Bearbeiten von Stahl
- Stahlborsten
- Draht: 0,30 mm

EAN 4047728067720



**V5512**

**Gas LötKolben Satz**

- Löt-, Schmelz-, Schrumpf-, Heißschneid-Arbeiten durch sieben verschiedene Adapter
- Gerät kombiniert drei Funktionen in einem:
    1. LötKolben, maximale Temperatur: 450 °C
    2. Brenner, maximale Temperatur: 1300 °C
    3. Heißluftfön, maximale Temperatur: 600 °C



EAN 4047728055123



**V6030**

**Schaber Satz**

- Entfernen u.a. von Plaketten, Aufklebern, Vignetten oder Kleberesten
- Weitere Anwendungsbereiche: Entfernen von Motordichtungen, z.B. am Zylinderkopf oder Ventildeckel
- Einfaches Auswechseln der Klingen durch Lösen der Verschraubung am Spannfutter
- Verschiedene Klingen ermöglichen Anpassung auf unterschiedliche Anwendungsbereiche



EAN 4047728060301



**Denk` dran, direkt mitbestellen!**

|   | VIGOR No. | Bezeichnung   | Klingenbreite mm | EAN 4047728+ |
|---|-----------|---------------|------------------|--------------|
| ① | V6030-12  | Ersatzklingen | 12               | 062121       |
| ② | V6030-16  | Ersatzklingen | 16               | 062138       |
| ③ | V6030-20  | Ersatzklingen | 20               | 062145       |



**V5540**

**LED Kopflampe**

- Auswählbare Modi, um punktuell oder ausleuchtendes Licht einzustellen
- 3 W LED Punktfokussierung maximal 185 lm
- 1,5 W COB-LED mit Weitwinkelausleuchtung maximal 130 lm

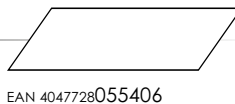

EAN 4047728055406



**V4969**

**LED Lampe**

- 3 Watt LED
- 90 Lumen Lichtstrom
- Stoßfestes Aluminiumgehäuse
- Einstellbarer Kopf zum Fokussieren
- Gürtelclip
- Inklusive 1 x AA Batterie
- Länge 110 mm

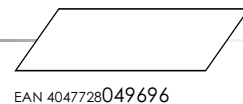

EAN 4047728049696

5 h

WERKZEUG, DAS SICH EINBRENNT.



[www.vigor-equipment.com](http://www.vigor-equipment.com)

EINFACH VIGOR.

Sprechen Sie uns an:

VIGOR GmbH · Am Langen Siepen 13-15 · 42857 Remscheid · GERMANY ·  
info@vigor-equipment.com



V-BIKE2021/DE/01. 12.2020/12. HO/MD Technische Änderungen und Irrtümer vorbehalten. Abbildungen können aus Darstellungsgründen vom Original abweichen und sind daher unverbindlich. Keine Haftung für Druckfehler! Copyright 2020 by VIGOR GmbH